



# 50MHz to 1000MHz High-Linearity, Serial/Analog-Controlled VGA

MAX2067

## General Description

The MAX2067 high-linearity analog variable-gain amplifier (VGA) is a monolithic SiGe BiCMOS attenuator and amplifier designed to interface with 50Ω systems operating in the 50MHz to 1000MHz frequency range (see the *Typical Application Circuit*). The analog attenuator is controlled using an external voltage or through the SPI™-compatible interface using an on-chip 8-bit DAC.

Because each stage has its own RF input and RF output, this component can be configured to either optimize NF (amplifier configured first), or OIP3 (amplifier last). The device's performance features include 22dB amplifier gain (amplifier only), 4dB NF at maximum gain (includes attenuator insertion loss), and a high OIP3 level of +43dBm. Each of these features makes the MAX2067 an ideal VGA for numerous receiver and transmitter applications.

In addition, the MAX2067 operates from a single +5V supply with full performance, or a single +3.3V supply with slightly reduced performance, and has an adjustable bias to trade current consumption for linearity performance. This device is available in a compact 40-pin thin QFN package (6mm x 6mm) with an exposed pad. Electrical performance is guaranteed over the extended temperature range (T<sub>C</sub> = -40°C to +85°C).

## Applications

IF and RF Gain Stages  
 Temperature Compensation Circuits  
 Cellular Band WCDMA and cdma2000® Base Stations  
 GSM 850/GSM 900 EDGE Base Stations  
 WiMAX and LTE Base Stations and Customer Premise Equipment  
 Fixed Broadband Wireless Access  
 Wireless Local Loop  
 Military Systems  
 Video-on-Demand (VOD) and DOCSIS®-Compliant EDGE QAM Modulation  
 Cable Modem Termination Systems (CMTS)  
 RFID Handheld and Portal Readers

## Features

- ◆ 50MHz to 1000MHz RF Frequency Range
- ◆ Pin-Compatible Family Includes
  - MAX2065 (Analog/Digital VGA)
  - MAX2066 (Digital VGA)
- ◆ +21.9dB (typ) Maximum Gain
- ◆ 0.5dB Gain Flatness Over 100MHz Bandwidth
- ◆ 31dB Gain Range
- ◆ Built-In DAC for Analog Attenuation Control
- ◆ Excellent Linearity (Configured with Amplifier Last)
  - +43dBm OIP3
  - +66dBm OIP2
  - +19dBm Output 1dB Compression Point
  - 70dBc HD2
  - 87dBc HD3
- ◆ 4dB Typical Noise Figure (NF)
- ◆ Single +5V Supply (Optional +3.3V Operation)
- ◆ External Current-Setting Resistors Provide Option for Operating Device in Reduced-Power/Reduced-Performance Mode

## Ordering Information

PART	TEMP RANGE	PIN-PACKAGE
MAX2067ETL+	-40°C to +85°C	40 Thin QFN-EP*
MAX2067ETL+T	-40°C to +85°C	40 Thin QFN-EP*

+Denotes a lead-free package.

\*EP = Exposed pad.

T = Tape and reel.

**Pin Configuration appears at end of data sheet.**

SPI is a trademark of Motorola, Inc.

cdma2000 is a registered trademark of Telecommunications Industry Association.

DOCSIS and CableLabs are registered trademarks of Cable Television Laboratories, Inc. (CableLabs®).



# 50MHz to 1000MHz High-Linearity, Serial/Analog-Controlled VGA

## ABSOLUTE MAXIMUM RATINGS

VCC_ to GND .....	-0.3V to +5.5V	RF Input Power (AMP_IN).....	+18dBm
VDD_LOGIC, DATA, $\overline{CS}$ , CLK, VDAC_EN, VREF_SELECT.....	-0.3V to (VCC_ + 0.3V)	Continuous Power Dissipation (Note 1) .....	6.5W
AMP_IN, AMP_OUT, VREF_IN, ANALOG_VCTRL .....	-0.3V to (VCC_ + 0.3V)	$\theta_{JA}$ (Notes 2, 3).....	+38°C/W
ATTEN_IN, ATTEN_OUT.....	-1.2V to +1.2V	$\theta_{JC}$ (Note 3) .....	+10°C/W
RSET to GND.....	-0.3V to +1.2V	Operating Temperature Range (Note 4).....	$T_C = -40^\circ\text{C}$ to $+85^\circ\text{C}$
RF Input Power (ATTEN_IN, ATTEN_OUT).....	+20dBm	Maximum Junction Temperature .....	+150°C
		Storage Temperature Range .....	-65°C to +150°C
		Lead Temperature (soldering, 10s) .....	+300°C

**Note 1:** Based on junction temperature  $T_J = T_C + (\theta_{JC} \times V_{CC} \times I_{CC})$ . This formula can be used when the temperature of the exposed pad is known while the device is soldered down to a printed-circuit board (PCB). See the *Applications Information* section for details. The junction temperature must not exceed +150°C.

**Note 2:** Junction temperature  $T_J = T_A + (\theta_{JA} \times V_{CC} \times I_{CC})$ . This formula can be used when the ambient temperature of the PCB is known. The junction temperature must not exceed +150°C.

**Note 3:** Package thermal resistances were obtained using the method described in JEDEC specification JESD51-7, using a 4-layer board. For detailed information on package thermal considerations, refer to [www.maxim-ic.com/thermal-tutorial](http://www.maxim-ic.com/thermal-tutorial).

**Note 4:**  $T_C$  is the temperature on the exposed pad of the package.  $T_A$  is the ambient temperature of the device and PCB.

Stresses beyond those listed under "Absolute Maximum Ratings" may cause permanent damage to the device. These are stress ratings only, and functional operation of the device at these or any other conditions beyond those indicated in the operational sections of the specifications is not implied. Exposure to absolute maximum rating conditions for extended periods may affect device reliability.

## +3.3V SUPPLY DC ELECTRICAL CHARACTERISTICS

(Typical Application Circuit, high-current (HC) mode,  $V_{CC} = V_{DD} = +3.0\text{V}$  to  $+3.6\text{V}$ ,  $T_C = -40^\circ\text{C}$  to  $+85^\circ\text{C}$ . Typical values are at  $V_{CC} = V_{DD} = +3.3\text{V}$  and  $T_C = +25^\circ\text{C}$ , unless otherwise noted.)

PARAMETER	SYMBOL	CONDITIONS	MIN	TYP	MAX	UNITS
Supply Voltage	$V_{CC}$	Note 5	3.0	3.3	3.6	V
Supply Current	$I_{CC}$			60	82	mA
<b>LOGIC INPUTS (DATA, <math>\overline{CS}</math>, CLK, VDAC_EN, VREF_SELECT)</b>						
Input High Voltage	$V_{IH}$			2		V
Input Low Voltage	$V_{IL}$			0.8		V

## +5V SUPPLY DC ELECTRICAL CHARACTERISTICS

(Typical Application Circuit,  $V_{CC} = V_{DD} = +4.75\text{V}$  to  $+5.25\text{V}$ ,  $T_C = -40^\circ\text{C}$  to  $+85^\circ\text{C}$ . Typical values are at  $V_{CC} = V_{DD} = +5\text{V}$  and  $T_C = +25^\circ\text{C}$ , unless otherwise noted.)

PARAMETER	SYMBOL	CONDITIONS	MIN	TYP	MAX	UNITS
Supply Voltage	$V_{CC}$		4.75	5	5.25	V
Supply Current	$I_{CC}$	Low-current (LC) mode		72	92	mA
		High-current (HC) mode		123	146	
<b>LOGIC INPUTS (DATA, <math>\overline{CS}</math>, CLK, VDAC_EN, VREF_SELECT)</b>						
Input High Voltage	$V_{IH}$		3			V
Input Low Voltage	$V_{IL}$				0.8	V
Input Current Logic-High	$I_{IH}$		-1		+1	$\mu\text{A}$
Input Current Logic-Low	$I_{IL}$		-1		+1	$\mu\text{A}$

# 50MHz to 1000MHz High-Linearity, Serial/Analog-Controlled VGA

MAX2067

## +3.3V SUPPLY AC ELECTRICAL CHARACTERISTICS

(Typical Application Circuit,  $V_{CC} = V_{DD} = +3.0V$  to  $+3.6V$ ,  $T_C = -40^\circ C$  to  $+85^\circ C$ . Typical values are at  $V_{CC} = V_{DD} = +3.3V$ , HC mode with attenuator set for maximum gain,  $P_{IN} = -20dBm$ ,  $f_{RF} = 200MHz$ , and  $T_C = +25^\circ C$ , unless otherwise noted.) (Note 6)

PARAMETER	SYMBOL	CONDITIONS	MIN	TYP	MAX	UNITS
RF Frequency Range	$f_{RF}$	(Notes 5, 7)	50		1000	MHz
Small-Signal Gain	G			21.3		dB
Output Third-Order Intercept Point	OIP3	$P_{OUT} = 0dBm/$ tone, maximum gain setting		38		dBm
Noise Figure	NF	Maximum gain setting		4.3		dB
Total Attenuation Range				31		dB

## +5V SUPPLY AC ELECTRICAL CHARACTERISTICS

(Typical Application Circuit,  $V_{CC} = V_{DD} = +4.75$  to  $+5.25V$ , HC mode with attenuator set for maximum gain,  $50MHz \leq f_{RF} \leq 1000MHz$ ,  $T_C = -40^\circ C$  to  $+85^\circ C$ . Typical values are at  $V_{CC} = V_{DD} = +5.0V$ , HC mode,  $P_{IN} = -20dBm$ ,  $f_{RF} = 200MHz$ , and  $T_C = +25^\circ C$ , unless otherwise noted.) (Note 6)

PARAMETER	SYMBOL	CONDITIONS	MIN	TYP	MAX	UNITS
RF Frequency Range	$f_{RF}$	(Notes 5, 7)	50		1000	MHz
Small-Signal Gain	G	200MHz		21.9		dB
		350MHz, $T_C = +25^\circ C$ (Note 5)	20.3	21.3	22.3	
		450MHz		20.9		
		750MHz		19.4		
		900MHz		18.7		
Gain Variation vs. Temperature				-0.006		dB/ $^\circ C$
Gain Flatness vs. Frequency		Any 100MHz frequency band from 50MHz to 500MHz		0.5		dB
Noise Figure	NF	200MHz		4		dB
		350MHz, $T_C = +25^\circ C$ (Note 5)		4.2	5.2	
		450MHz		4.3		
		750MHz		4.8		
		900MHz		5		
Total Attenuation Range				31		dB
Output Second-Order Intercept Point	OIP2	$P_{OUT} = 0dBm/$ tone, $\Delta f = 1MHz$ , $f_1 + f_2$		66		dBm
Output Third-Order Intercept Point	OIP3	$P_{OUT} = 0dBm/$ tone, HC mode, $\Delta f = 1MHz$	200MHz		43	dBm
			350MHz		40.8	
			450MHz		39.8	
			750MHz		37.3	
			900MHz		36.2	
		$P_{OUT} = 0dBm/$ tone, LC mode, $\Delta f = 1MHz$	200MHz		40	
			350MHz		38.2	
			450MHz		37.4	
			750MHz		35.5	
			900MHz		34.3	

# 50MHz to 1000MHz High-Linearity, Serial/Analog-Controlled VGA

## +5V SUPPLY AC ELECTRICAL CHARACTERISTICS (continued)

(Typical Application Circuit,  $V_{CC} = V_{DD} = +4.75$  to  $+5.25V$ , HC mode with attenuator set for maximum gain,  $50MHz \leq f_{RF} \leq 1000MHz$ ,  $T_C = -40^\circ C$  to  $+85^\circ C$ . Typical values are at  $V_{CC} = V_{DD} = +5.0V$ , HC mode,  $P_{IN} = -20dBm$ ,  $f_{RF} = 200MHz$ , and  $T_C = +25^\circ C$ , unless otherwise noted.) (Note 6)

PARAMETER	SYMBOL	CONDITIONS	MIN	TYP	MAX	UNITS
Output -1dB Compression Point	$P_{1dB}$	350MHz, $T_C = +25^\circ C$ (Notes 5, 8)	17	18.7		dBm
Second Harmonic		$P_{OUT} = +3dBm$ , $f_{RF} = 200MHz$ , $T_C = +25^\circ C$ (Note 5)	-61	-70		dBc
Third Harmonic		$P_{OUT} = +3dBm$ , $f_{RF} = 200MHz$ , $T_C = +25^\circ C$ (Note 5)	-74	-87		dBc
Attenuator Response Time (Note 9)		Input from ANALOG_VCTRL		1		$\mu s$
		Input from $\overline{CS}$ rising edge		3.2		
Group Delay		Maximum gain setting, includes EV kit PCB delays		0.8		ns
Input Return Loss		50 $\Omega$ source, maximum gain setting		30		dB
Output Return Loss		50 $\Omega$ load, maximum gain setting		16		dB
<b>ANALOG ATTENUATOR</b>						
Insertion Loss				1.2		dB
Input Second-Order Intercept Point	IIP2	$P_{RF1} = 0dBm$ , $P_{RF2} = 0dBm$ , maximum gain setting, $\Delta f = 1MHz$ , $f_1 + f_2$		70		dBm
Input Third-Order Intercept Point	IIP3	$P_{RF1} = 0dBm$ , $P_{RF2} = 0dBm$ , maximum gain setting, $\Delta f = 1MHz$		36		dBm
Attenuation Range		Analog control input		31		dB
Gain-Control Slope		Analog control input		-12.5		dB/V
Maximum Gain-Control Slope		Over analog control input range		-35		dB/V
Insertion Phase Change		Over analog control input range		18		Degrees
Group Delay vs. Control Voltage		Over analog control input range		-0.25		ns
Analog Control Input Range			0.25		2.75	V
Analog Control Input Impedance				80		k $\Omega$
Input Return Loss		50 $\Omega$ source, maximum gain setting		22		dB
Output Return Loss		50 $\Omega$ load, maximum gain setting		22		dB
<b>DAC</b>						
Number of Bits				8		Bits
Output Voltage		DAC code = 00000000			0.25	V
		DAC code = 11111111	2.75			

# 50MHz to 1000MHz High-Linearity, Serial/Analog-Controlled VGA

MAX2067

## +5V SUPPLY AC ELECTRICAL CHARACTERISTICS (continued)

(Typical Application Circuit,  $V_{CC} = V_{DD} = +4.75$  to  $+5.25V$ , HC mode with attenuator set for maximum gain,  $50MHz \leq f_{RF} \leq 1000MHz$ ,  $T_C = -40^\circ C$  to  $+85^\circ C$ . Typical values are at  $V_{CC} = V_{DD} = +5.0V$ , HC mode,  $P_{IN} = -20dBm$ ,  $f_{RF} = 200MHz$ , and  $T_C = +25^\circ C$ , unless otherwise noted.) (Note 6)

PARAMETER	SYMBOL	CONDITIONS	MIN	TYP	MAX	UNITS
<b>SERIAL PERIPHERAL INTERFACE (SPI)</b>						
Maximum Clock Speed	f <sub>CLK</sub>			20		MHz
Data-to-Clock Setup Time	t <sub>CS</sub>			2		ns
Data-to-Clock Hold Time	t <sub>CH</sub>			2.5		ns
Clock-to- $\overline{CS}$ Setup Time	t <sub>ES</sub>			3		ns
$\overline{CS}$ Positive Pulse Width	t <sub>EW</sub>			7		ns
$\overline{CS}$ Setup Time	t <sub>EWS</sub>			3.5		ns
Clock Pulse Width	t <sub>CW</sub>			5		ns

**Note 5:** Guaranteed by design and characterization.

**Note 6:** All limits include external component losses. Output measurements are performed at RF output port of the *Typical Application Circuit*

**Note 7:** Operating outside this range is possible, but with degraded performance of some parameters.

**Note 8:** It is advisable not to continuously operate the VGA RF input above +15dBm.

**Note 9:** Response time includes full attenuation range change with output setting to within  $\pm 0.1dB$ .

# 50MHz to 1000MHz High-Linearity, Serial/Analog-Controlled VGA

## Typical Operating Characteristics

( $V_{CC} = V_{DD} = +5.0V$ , HC mode, attenuator set for maximum gain,  $P_{IN} = -20dBm$ ,  $f_{RF} = 200MHz$ , and  $T_C = +25^\circ C$ , internal DAC reference used, unless otherwise noted.)

**SUPPLY CURRENT vs. SUPPLY VOLTAGE**

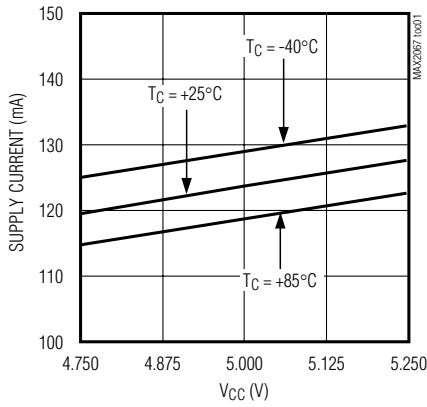

**GAIN vs. RF FREQUENCY**

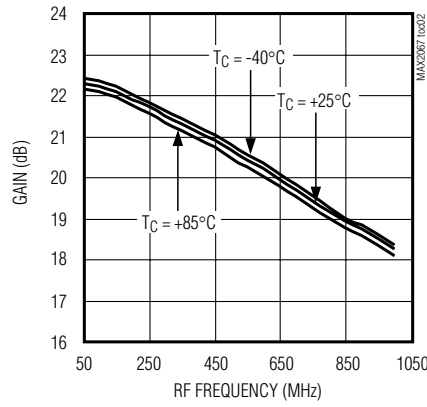

**GAIN vs. RF FREQUENCY**

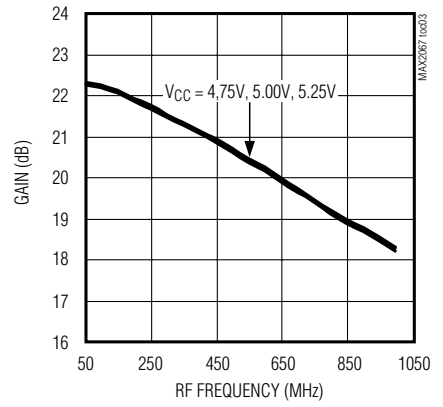

**GAIN OVER ATTENUATOR SETTING vs. RF FREQUENCY**

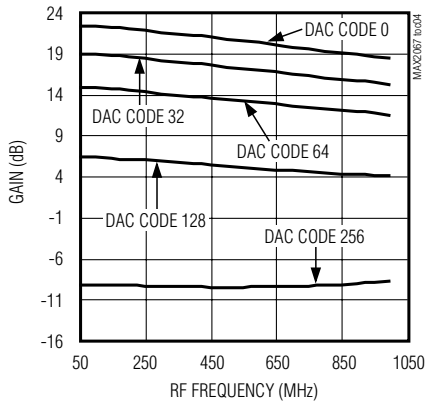

**GAIN vs. ATTENUATOR SETTING**

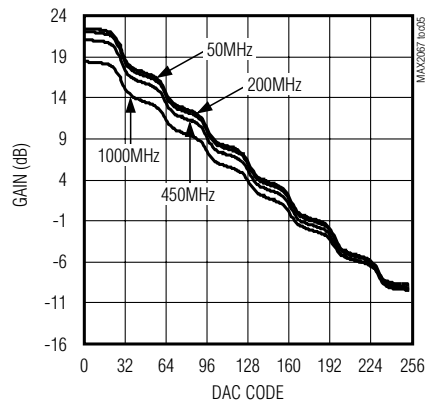

**GAIN vs. ATTENUATOR SETTING**

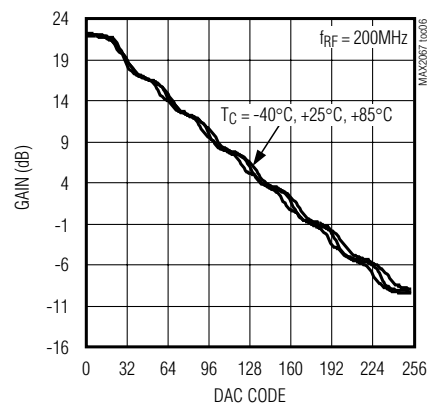

**GAIN vs. ATTENUATOR SETTING**

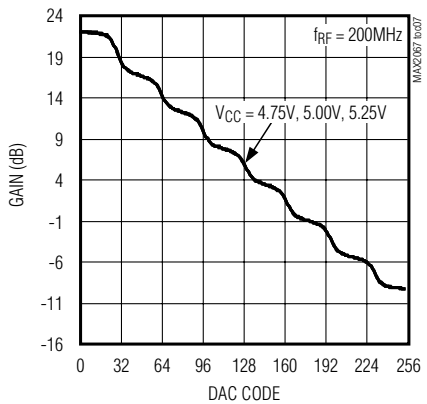

**INPUT MATCH vs. ATTENUATOR SETTING**

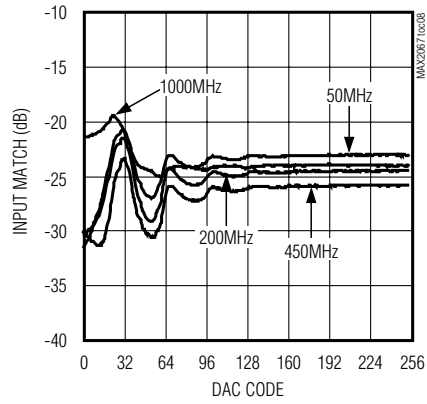

**OUTPUT MATCH vs. ATTENUATOR SETTING**

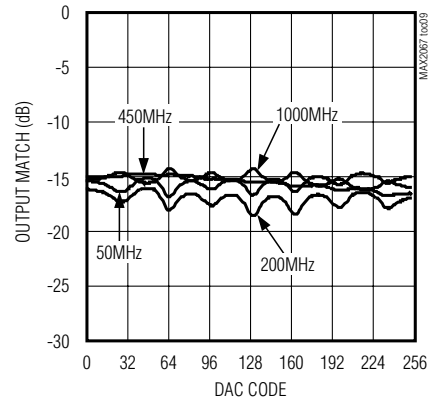

# 50MHz to 1000MHz High-Linearity, Serial/Analog-Controlled VGA

MAX2067

## Typical Operating Characteristics (continued)

( $V_{CC} = V_{DD} = +5.0V$ , HC mode, attenuator set for maximum gain,  $P_{IN} = -20dBm$ ,  $f_{RF} = 200MHz$ , and  $T_C = +25^\circ C$ , internal DAC reference used, unless otherwise noted.)

**REVERSE ISOLATION OVER ATTENUATOR SETTING vs. RF FREQUENCY**

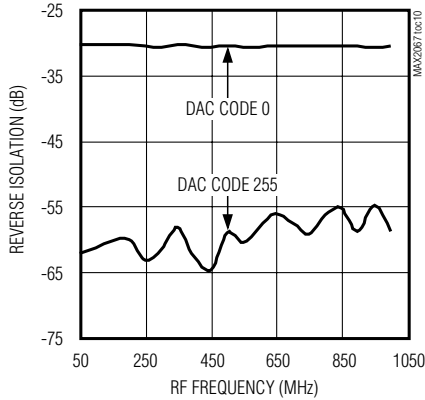

**S21 PHASE CHANGE vs. ATTENUATOR SETTING**

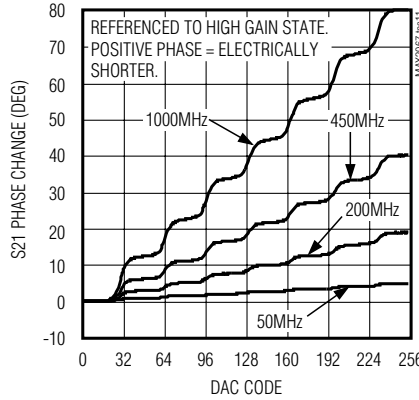

**NOISE FIGURE vs. RF FREQUENCY**

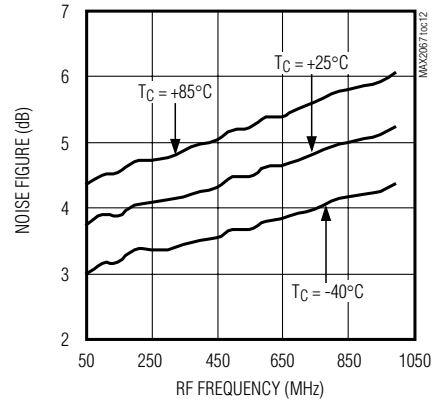

**NOISE FIGURE vs. RF FREQUENCY**

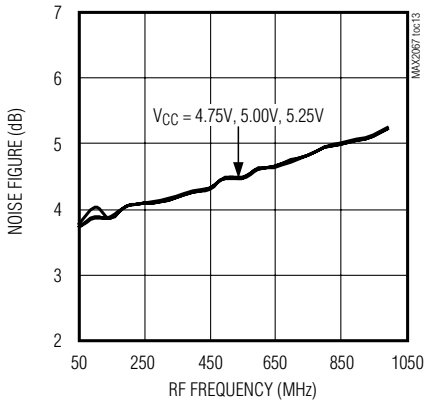

**OUTPUT  $P_{1dB}$  vs. RF FREQUENCY**

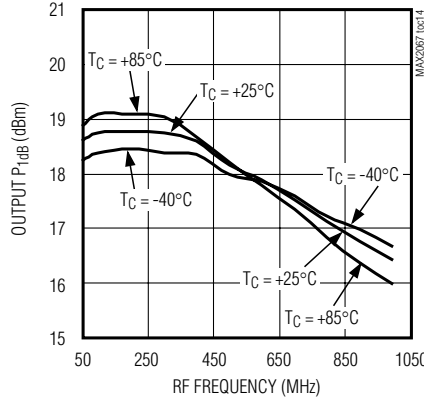

**OUTPUT  $P_{1dB}$  vs. RF FREQUENCY**

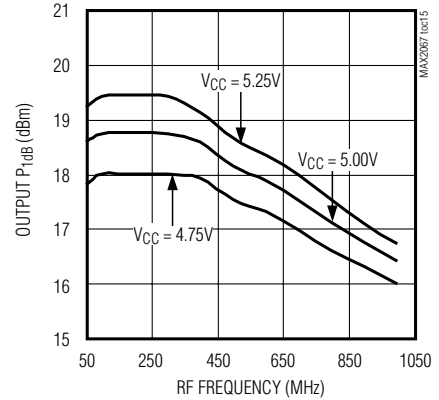

**OUTPUT IP3 vs. RF FREQUENCY**

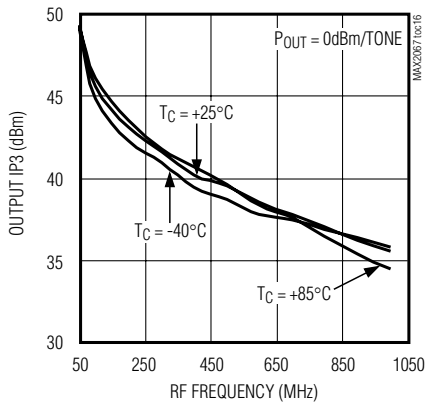

**OUTPUT IP3 vs. RF FREQUENCY**

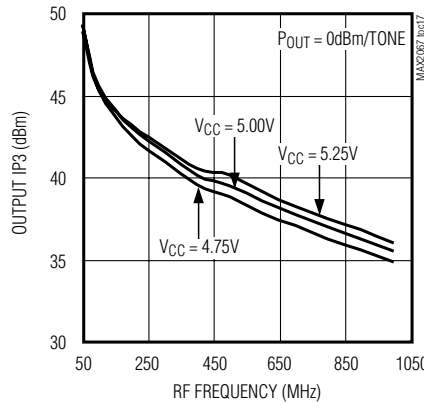

**OUTPUT IP3 vs. ATTENUATOR STATE**

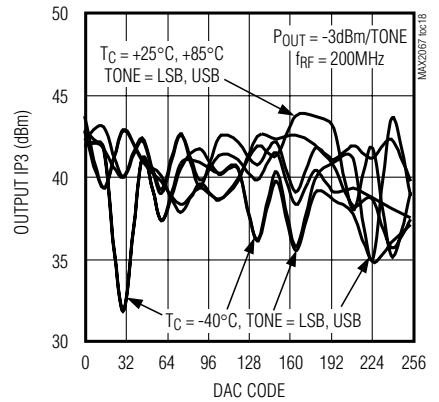

# 50MHz to 1000MHz High-Linearity, Serial/Analog-Controlled VGA

## Typical Operating Characteristics (continued)

( $V_{CC} = V_{DD} = +5.0V$ , HC mode, attenuator set for maximum gain,  $P_{IN} = -20dBm$ ,  $f_{RF} = 200MHz$ , and  $T_C = +25^\circ C$ , internal DAC reference used, unless otherwise noted.)

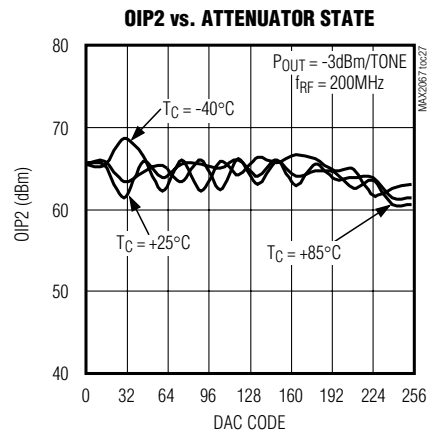
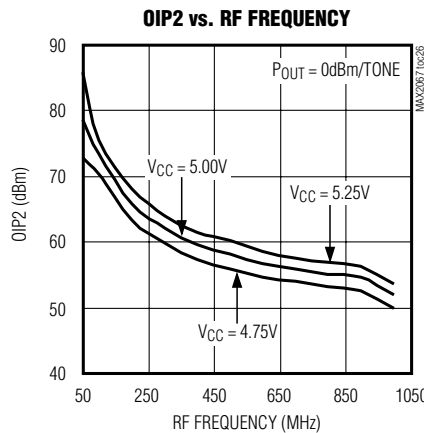
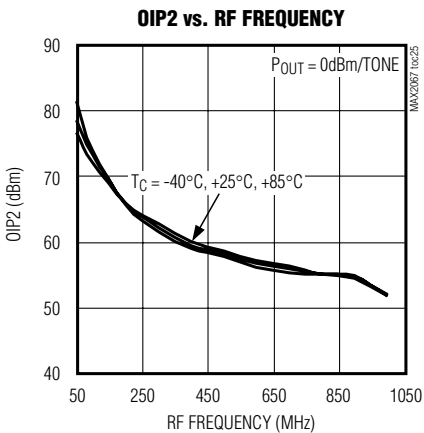
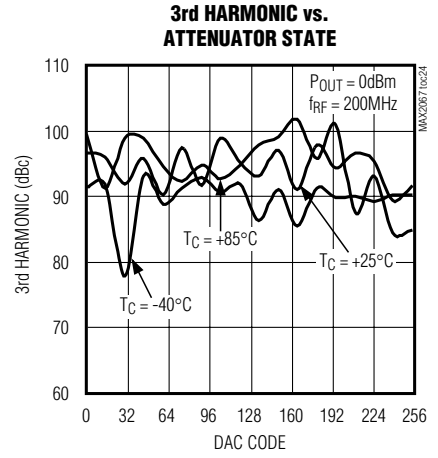
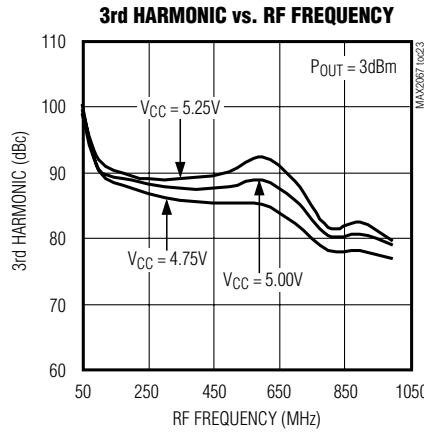
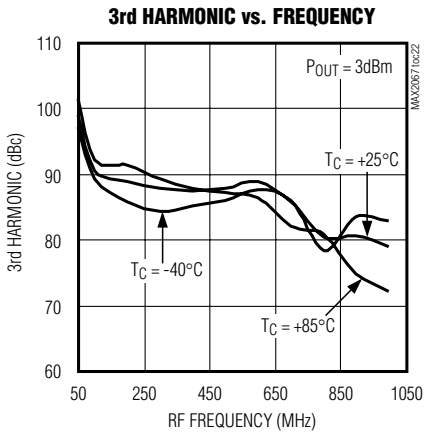
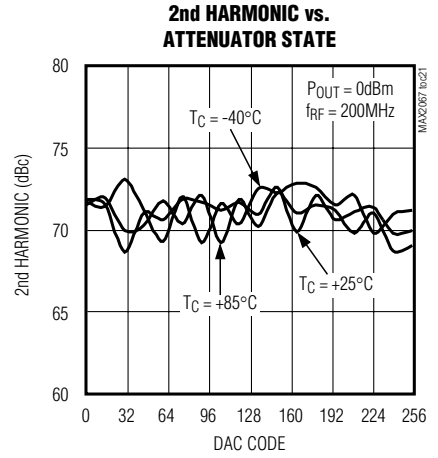
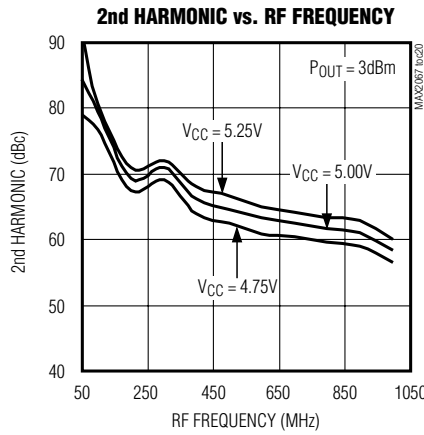
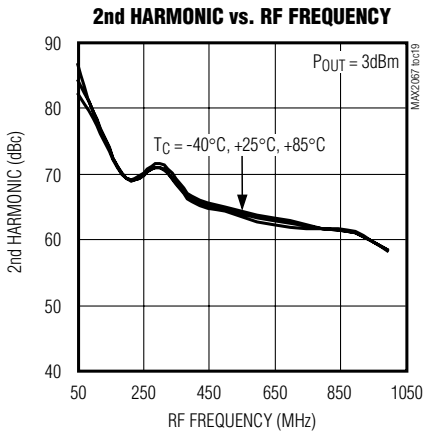



# 50MHz to 1000MHz High-Linearity, Serial/Analog-Controlled VGA

MAX2067

## Typical Operating Characteristics (continued)

( $V_{CC} = V_{DD} = +5.0V$ , HC mode, attenuator set for maximum gain,  $P_{IN} = -20dBm$ ,  $f_{RF} = 200MHz$ , and  $T_C = +25^\circ C$ , internal DAC reference used, unless otherwise noted.)

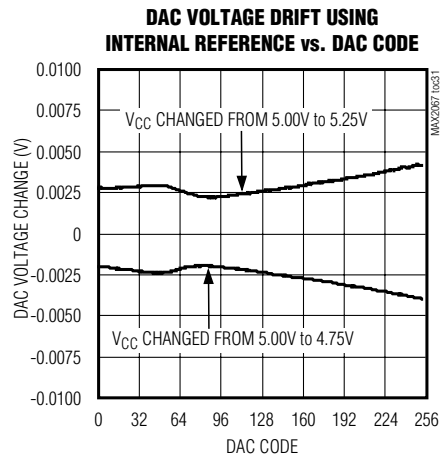
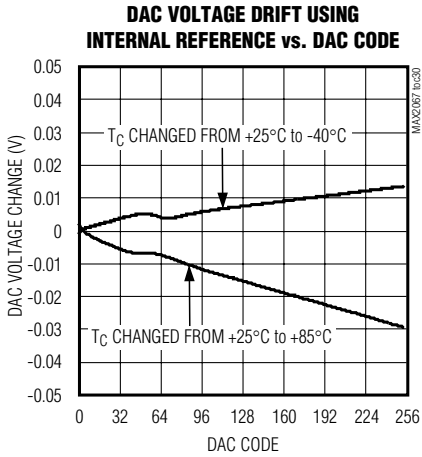
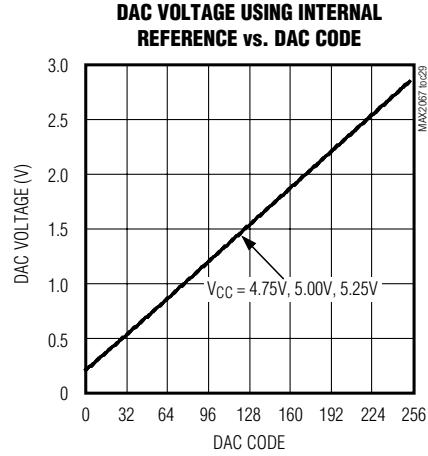
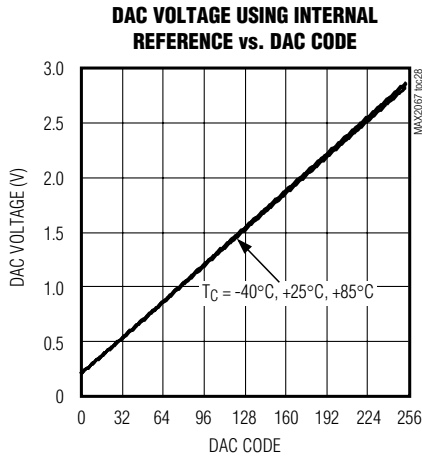

# 50MHz to 1000MHz High-Linearity, Serial/Analog-Controlled VGA

## Typical Operating Characteristics (continued)

( $V_{CC} = V_{DD} = +5.0V$ , attenuator only, maximum gain,  $P_{IN} = -20dBm$ , and  $T_C = +25^\circ C$ , unless otherwise noted.)

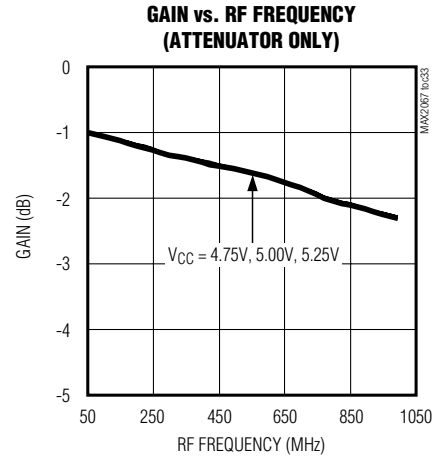
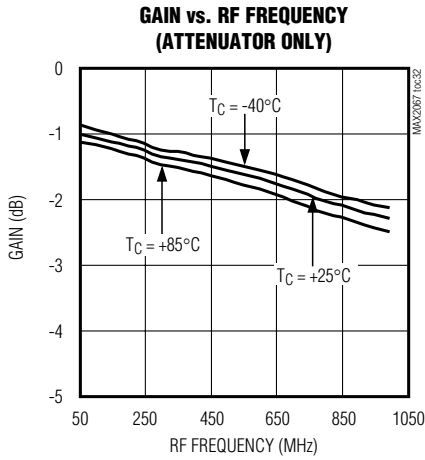

# 50MHz to 1000MHz High-Linearity, Serial/Analog-Controlled VGA

MAX2067

## Typical Operating Characteristics (continued)

( $V_{CC} = V_{DD} = +5.0V$ , LC mode, attenuator set for maximum gain,  $P_{IN} = -20dBm$ ,  $f_{RF} = 200MHz$ , and  $T_C = +25^\circ C$ , internal DAC reference used, unless otherwise noted.)

**SUPPLY CURRENT vs. SUPPLY VOLTAGE (LOW-CURRENT MODE)**

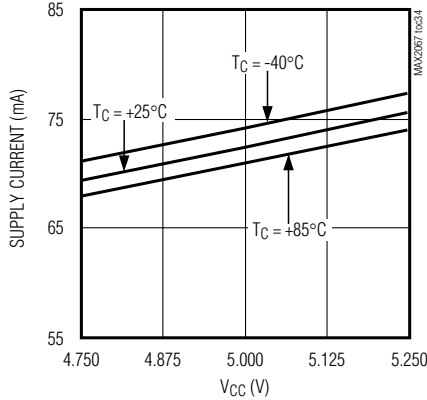

**GAIN vs. RF FREQUENCY (LOW-CURRENT MODE)**

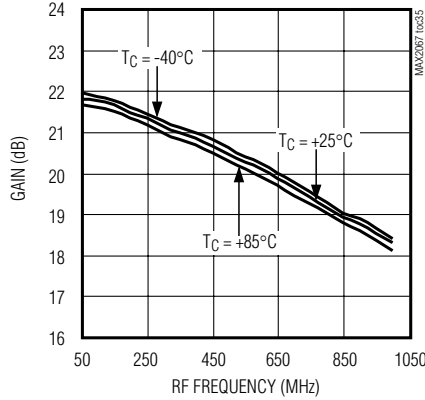

**GAIN vs. RF FREQUENCY (LOW-CURRENT MODE)**

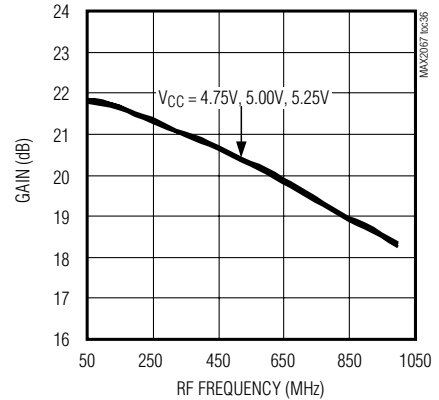

**INPUT MATCH vs. ATTENUATOR SETTING (LOW-CURRENT MODE)**

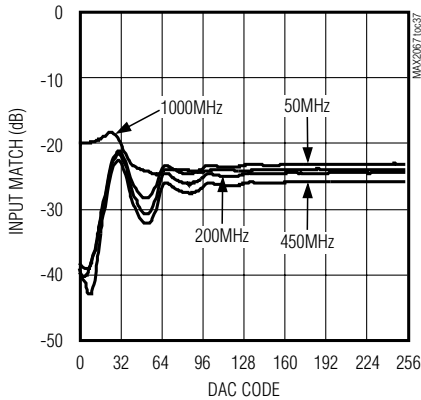

**OUTPUT MATCH vs. ATTENUATOR SETTING (LOW-CURRENT MODE)**

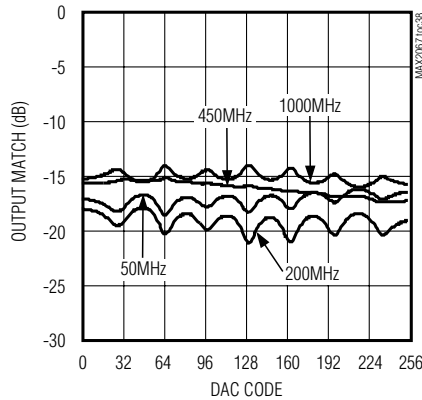

**NOISE FIGURE vs. RF FREQUENCY (LOW-CURRENT MODE)**

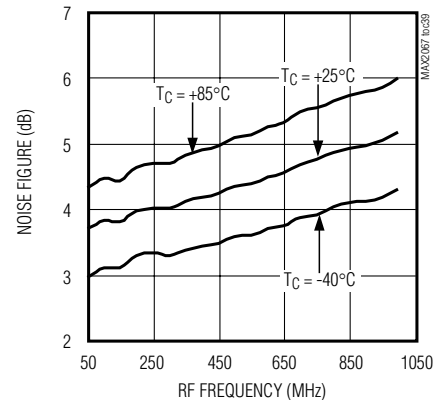

**NOISE FIGURE vs. RF FREQUENCY (LOW-CURRENT MODE)**

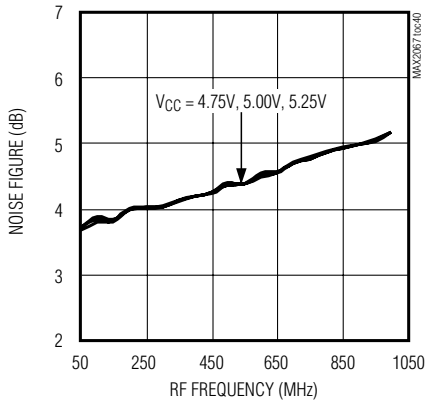

**OUTPUT P<sub>1dB</sub> vs. RF FREQUENCY (LOW-CURRENT MODE)**

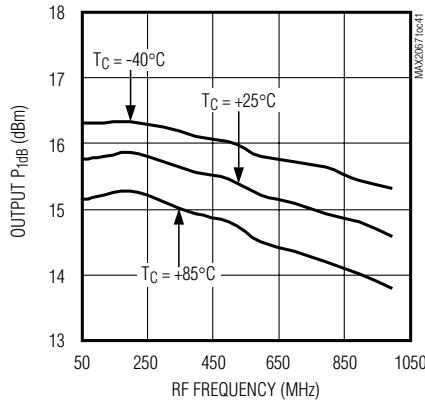

**OUTPUT P<sub>1dB</sub> vs. RF FREQUENCY (LOW-CURRENT MODE)**

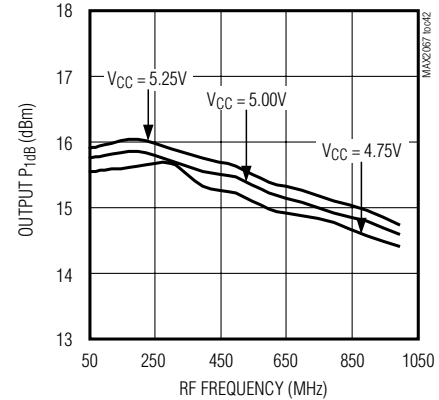

# 50MHz to 1000MHz High-Linearity, Serial/Analog-Controlled VGA

## Typical Operating Characteristics (continued)

( $V_{CC} = V_{DD} = +5.0V$ , LC mode, attenuator set for maximum gain,  $P_{IN} = -20dBm$ ,  $f_{RF} = 200MHz$ , and  $T_C = +25^\circ C$ , internal DAC reference used, unless otherwise noted.)

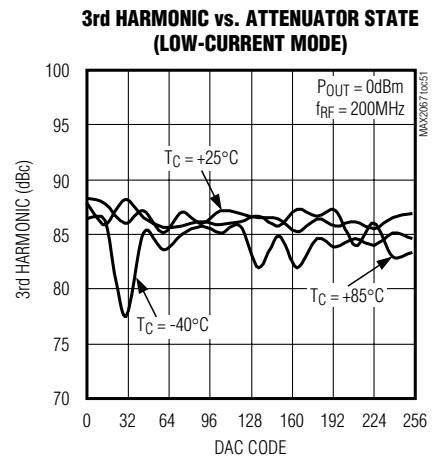
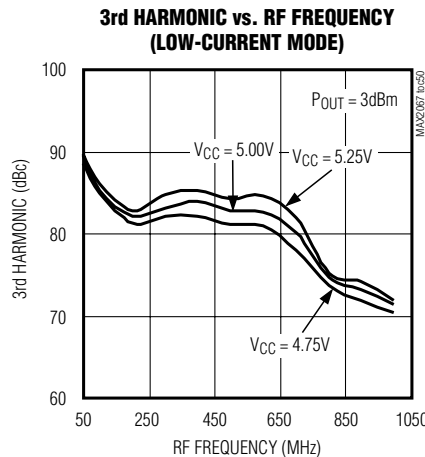
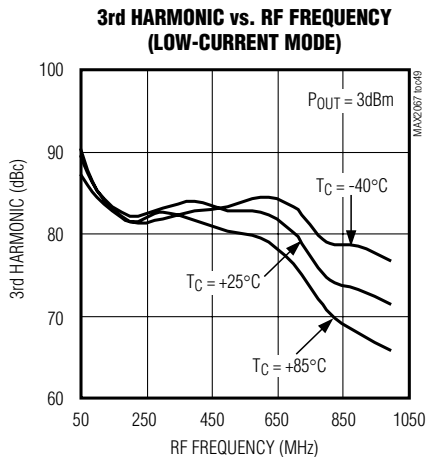
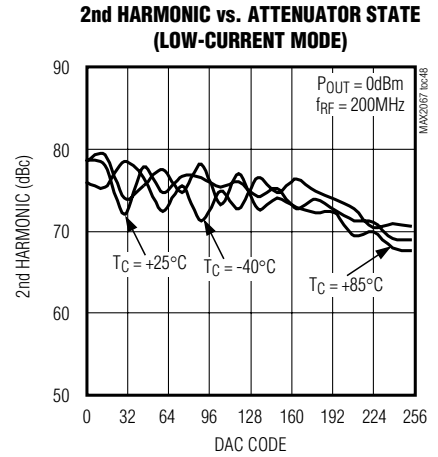
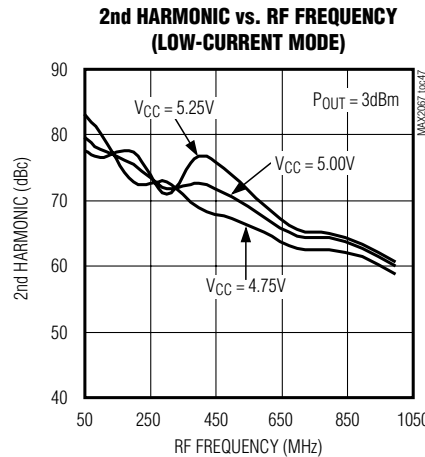
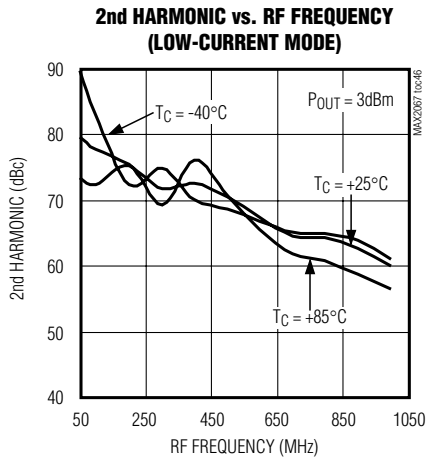
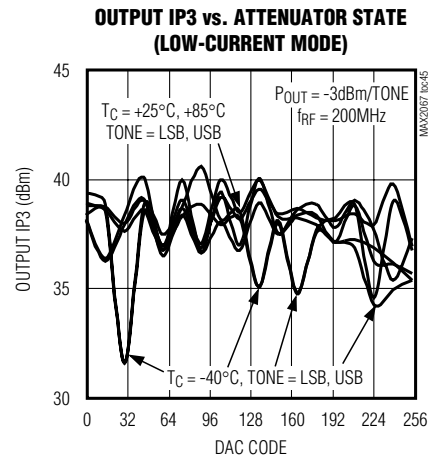
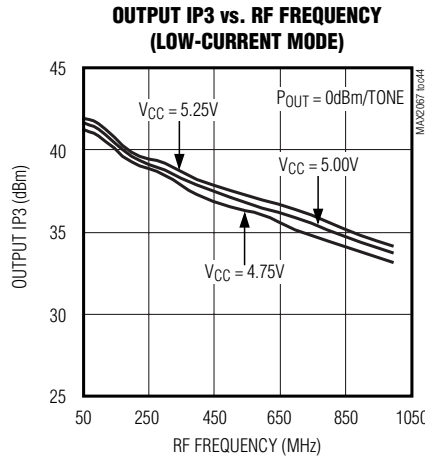
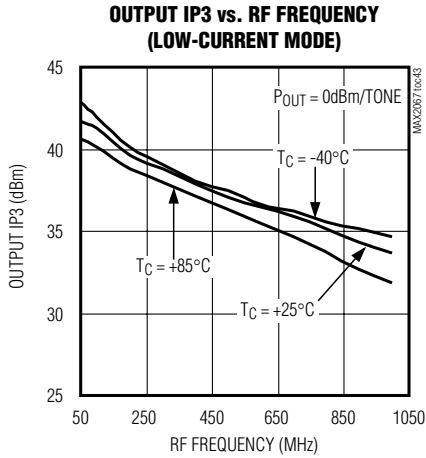

# 50MHz to 1000MHz High-Linearity, Serial/Analog-Controlled VGA

MAX2067

## Typical Operating Characteristics (continued)

( $V_{CC} = V_{DD} = +5.0V$ , LC mode, attenuator set for maximum gain,  $P_{IN} = -20dBm$ ,  $f_{RF} = 200MHz$ , and  $T_C = +25^\circ C$ , internal DAC reference used, unless otherwise noted.)

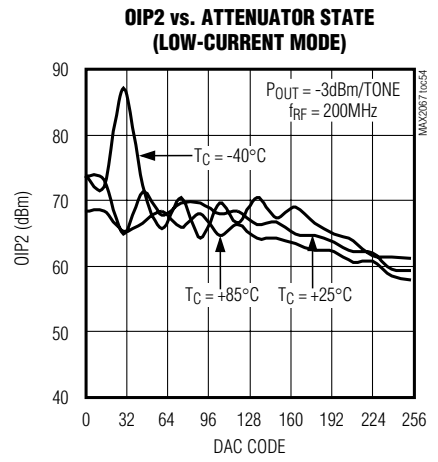
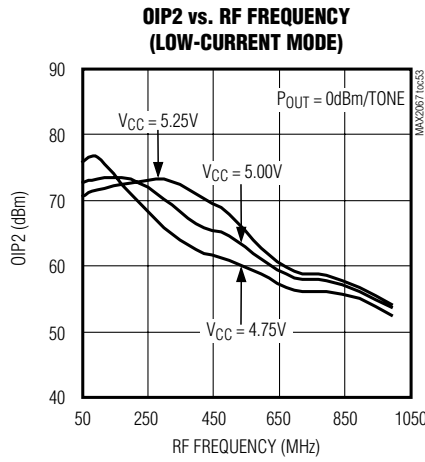
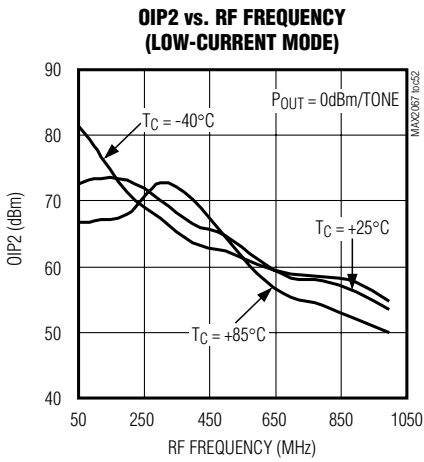

# 50MHz to 1000MHz High-Linearity, Serial/Analog-Controlled VGA

## Typical Operating Characteristics (continued)

( $V_{CC} = V_{DD} = +3.3V$ , HC mode, attenuator set for maximum gain,  $P_{IN} = -20dBm$ ,  $f_{RF} = 200MHz$ , and  $T_C = +25^\circ C$ , internal DAC reference used, unless otherwise noted.)

**SUPPLY CURRENT vs. SUPPLY VOLTAGE**

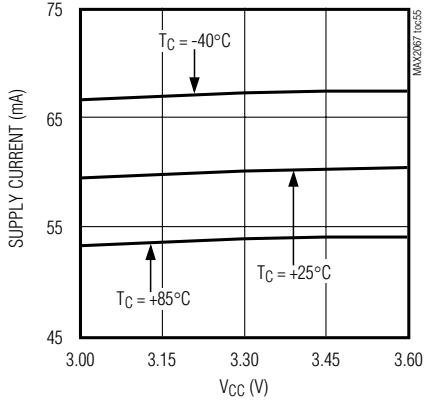

**GAIN vs. RF FREQUENCY**

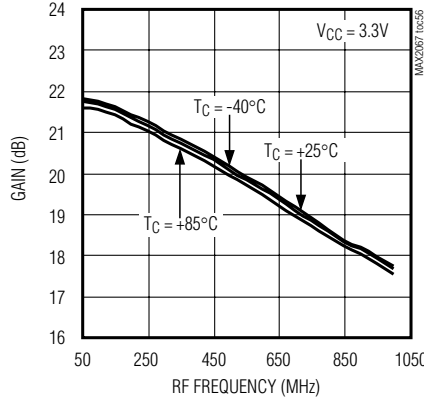

**GAIN vs. RF FREQUENCY**

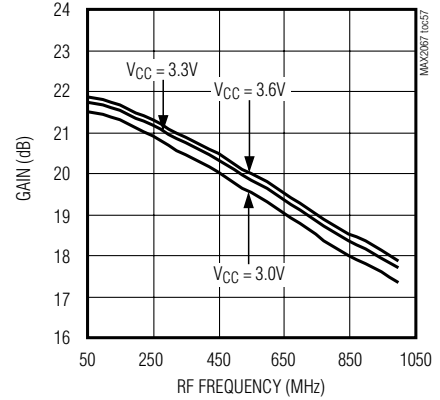

**INPUT MATCH vs. ATTENUATOR SETTING**

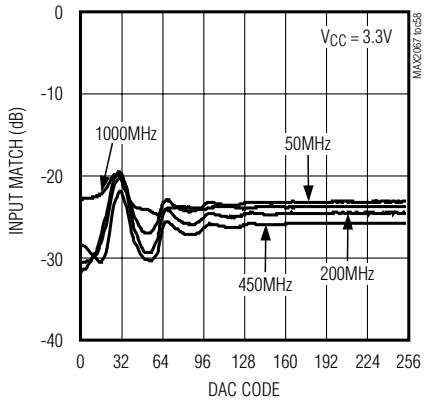

**OUTPUT MATCH vs. ATTENUATOR SETTING**

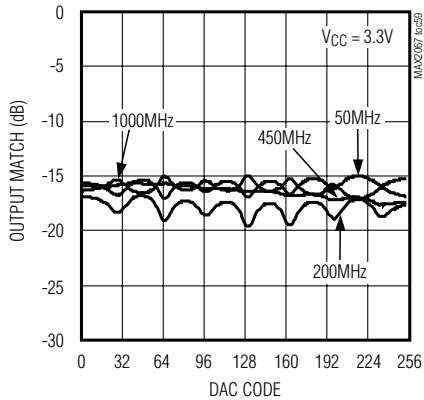

**NOISE FIGURE vs. RF FREQUENCY**

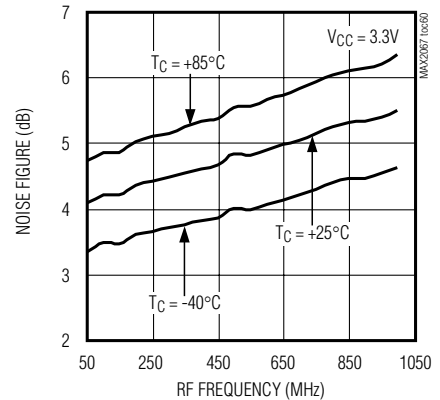

**NOISE FIGURE vs. RF FREQUENCY**

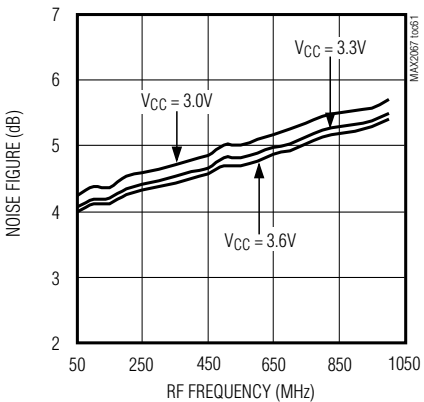

**OUTPUT P1dB vs. RF FREQUENCY**

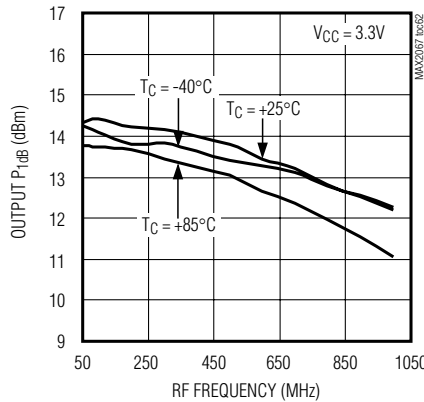

**OUTPUT P1dB vs. RF FREQUENCY**

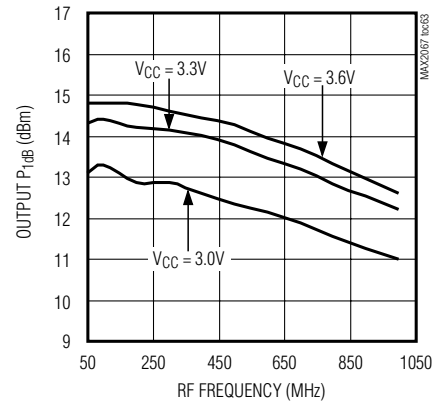

# 50MHz to 1000MHz High-Linearity, Serial/Analog-Controlled VGA

MAX2067

## Typical Operating Characteristics (continued)

( $V_{CC} = V_{DD} = +3.3V$ , HC mode, attenuator set for maximum gain,  $P_{IN} = -20dBm$ ,  $f_{RF} = 200MHz$ , and  $T_C = +25^\circ C$ , internal DAC reference used, unless otherwise noted.)

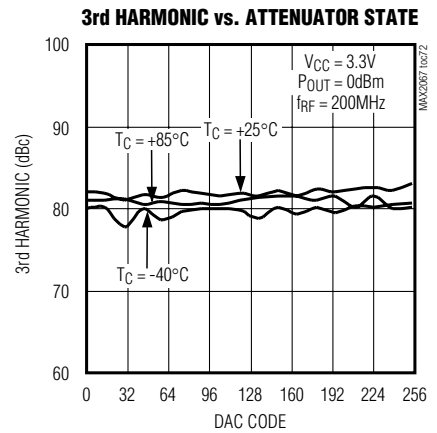
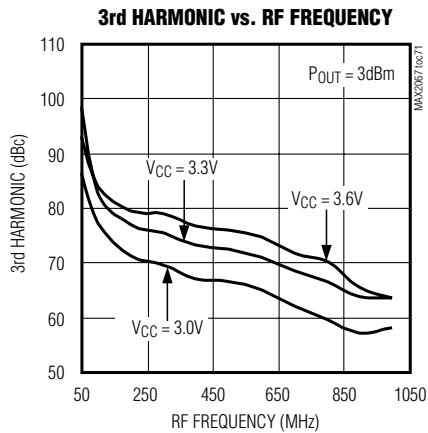
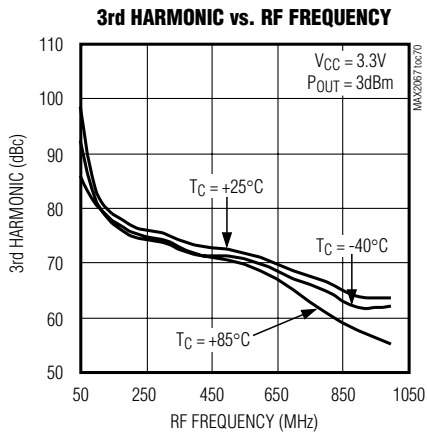
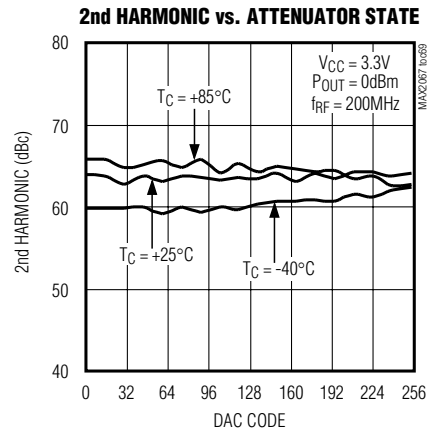
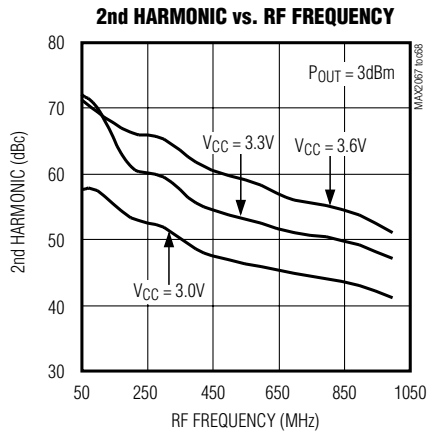
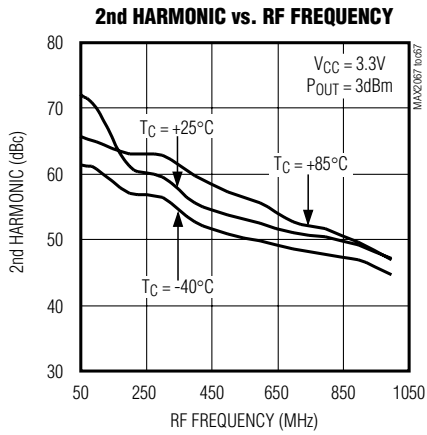
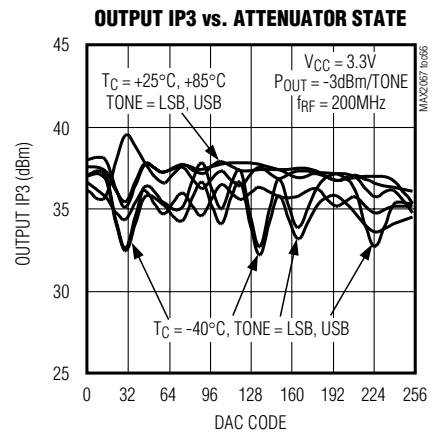
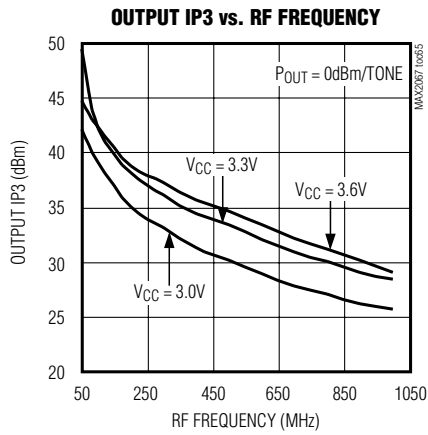
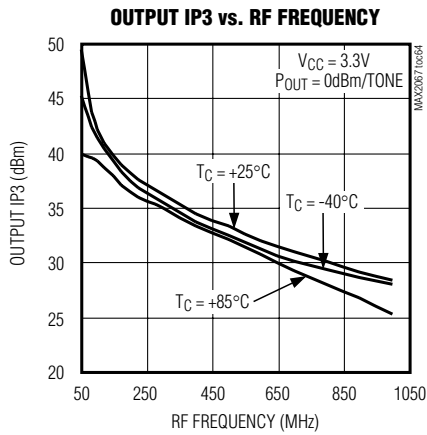

# 50MHz to 1000MHz High-Linearity, Serial/Analog-Controlled VGA

## Typical Operating Characteristics (continued)

( $V_{CC} = V_{DD} = +3.3V$ , HC mode, attenuator set for maximum gain,  $P_{IN} = -20dBm$ ,  $f_{RF} = 200MHz$ , and  $T_C = +25^\circ C$ , internal DAC reference used, unless otherwise noted.)

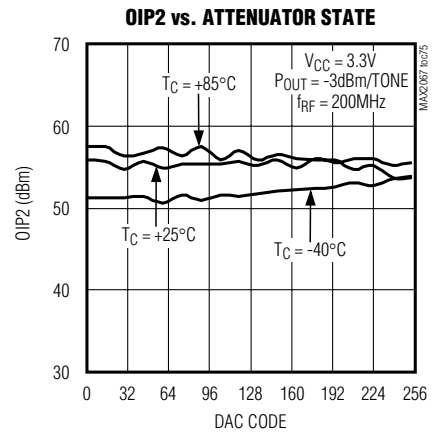
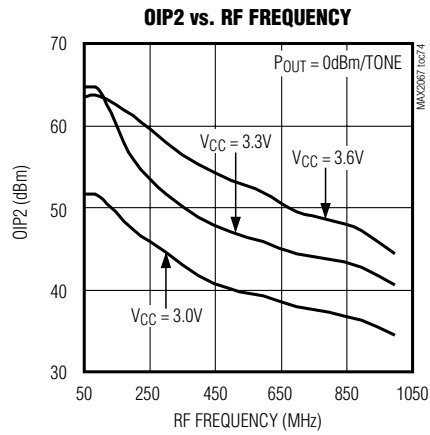
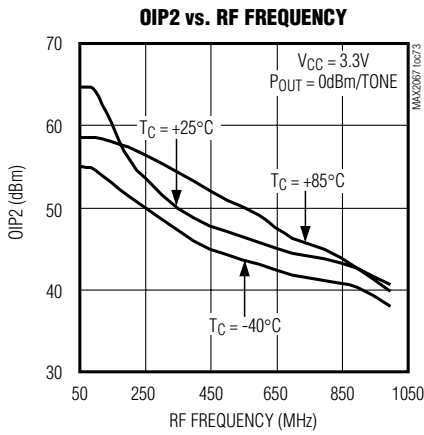



# 50MHz to 1000MHz High-Linearity, Serial/Analog-Controlled VGA

## Pin Description

MAX2067

PIN	NAME	DESCRIPTION
1, 16, 19, 22, 24–28, 30, 31, 33–36	GND	Ground
2	VREF_SELECT	DAC Reference Voltage Selection Logic Input. Logic 1 = internal DAC reference voltage, Logic 0 = external DAC reference voltage. Logic input disabled (don't care) when VDAC_EN = Logic 0.
3	VDAC_EN	DAC Enable/Disable Logic Input. Logic 0 = disable DAC circuit, Logic 1 = enable DAC circuit.
4	DATA	SPI Data Digital Input
5	CLK	SPI Clock Digital Input
6	$\overline{CS}$	SPI Chip-Select Digital Input
7	VDD_LOGIC	Digital Logic Supply Input. Connect to the digital logic power supply, V <sub>DD</sub> , Bypass to GND with a 10nF capacitor as close as possible to the pin.
8–15, 23, 29	GND	Ground. See the <i>Pin-Compatibility Considerations</i> section.
17	AMP_OUT	Driver Amplifier Output (50Ω). See the <i>Typical Application Circuit</i> for details.
18	RSET	Driver Amplifier Bias-Setting Input. See the <i>External Bias</i> section.
20	AMP_IN	Driver Amplifier Input (50Ω). See the <i>Typical Application Circuit</i> for details.
21	VCC_AMP	Driver Amplifier Supply Voltage Input. Connect to the V <sub>CC</sub> power supply. Bypass to GND with 1000pF and 10nF capacitors as close as possible to the pin, with the smaller value capacitor closer to the part.
32	ATTEN_OUT	Analog Attenuator Output. Internally matched to 50Ω. Requires an external DC-blocking capacitor.
37	ATTEN_IN	Analog Attenuator Input. Internally matched to 50Ω. Requires an external DC-blocking capacitor.
38	VCC_ANALOG	Analog Bias and Control Supply Voltage Input. Bypass to GND with a 10nF capacitor as close as possible to the pin.
39	ANALOG_VCTRL	Analog Attenuator Voltage-Control Input
40	VREF_IN	External DAC Voltage Reference Input
—	EP	Exposed Pad. Internally connected to GND. Connect EP to ground for proper RF performance and enhanced thermal dissipation.

# 50MHz to 1000MHz High-Linearity, Serial/Analog-Controlled VGA

## Detailed Description

The MAX2067 high-linearity analog variable-gain amplifier is a general-purpose, high-performance amplifier designed to interface with 50Ω systems operating in the 50MHz to 1000MHz frequency range.

The MAX2067 integrates an analog attenuator to provide 31dB of total gain control, as well as a driver amplifier optimized to provide high gain, high IP3, low noise figure, and low power consumption. For applications that do not require high linearity, the bias current of the amplifier can be adjusted by an external resistor to further reduce power consumption.

The analog attenuator is controlled using an external voltage or through the SPI-compatible interface using an on-chip DAC. Because each stage has its own external RF input and RF output, this component can be configured to either optimize NF (amplifier configured first), or OIP3 (amplifier last). The device's performance features include 22dB stand-alone amplifier gain (amplifier only), 4dB NF at maximum gain (includes attenuator insertion loss), and a high OIP3 level of +43dBm. Each of these features makes the MAX2067 an ideal VGA for numerous receiver and transmitter applications.

In addition, the MAX2067 operates from a single +5V supply, or a single +3.3V supply with slightly reduced performance, and has adjustable bias to trade current consumption for linearity performance.

### Analog Attenuator

The MAX2067's analog attenuator has a dynamic range of 31dB and is controlled using an external voltage or through the 3-wire SPI using an on-chip 8-bit DAC. See the *Applications Information* section and Table 1 for attenuator programming details. The attenuator can be used for both static and dynamic power control.

### Driver Amplifier

The MAX2067 includes a high-performance driver with a fixed gain of 22dB. The driver amplifier circuit is optimized for high linearity for the 50MHz to 1000MHz frequency range.

## Applications Information

### Attenuator Control

The analog attenuator is controlled by either an external control voltage applied at ANALOG\_VCTRL (pin 39) or by the on-chip 8-bit DAC. Through the utilization of this control DAC, the user can easily adjust the analog attenuation in 0.12dB increments through a simple SPI command. The DAC enable/disable logic-input pin (VDAC\_EN), and the DAC reference voltage selection logic-input pin (VREF\_SELECT) determine how the attenuator is controlled. When the DAC is enabled, either the on-chip voltage reference or the external voltage reference can be selected. See Table 1 for the attenuator and DAC operation truth table.

Although this on-chip DAC eliminates the need for an external analog control voltage, the user still has the option of disabling the DAC and using an external analog control voltage for instances where additional attenuation resolution is needed, or in cases where the gain trim/automatic gain-control (AGC) loop is purely analog.

### SPI Interface and Attenuator Settings

The MAX2067 employs a 3-wire SPI/MICROWIRE™-compatible serial interface to program the on-chip DAC. Eight bits of data are shifted in MSB first and framed by  $\overline{CS}$ . When  $\overline{CS}$  is low, the clock is active and data is shifted on the rising edge of the clock. When  $\overline{CS}$  transitions high, the data is latched and the attenuator setting changes (Figure 1). See Table 2 for details on the SPI data format.

**Table 1. Control Logic**

VDAC_EN	VREF_SELECT	ANALOG ATTENUATOR	D/A CONVERTER
0	X	Controlled by external control voltage	Disabled
1	1	Controlled by on-chip DAC	Enabled (DAC uses on-chip voltage reference)
1	0	Controlled by on-chip DAC	Enabled (DAC uses external voltage reference)

X = Don't care.

MICROWIRE is a trademark of National Semiconductor Corp.

# 50MHz to 1000MHz High-Linearity, Serial/Analog-Controlled VGA

MAX2067

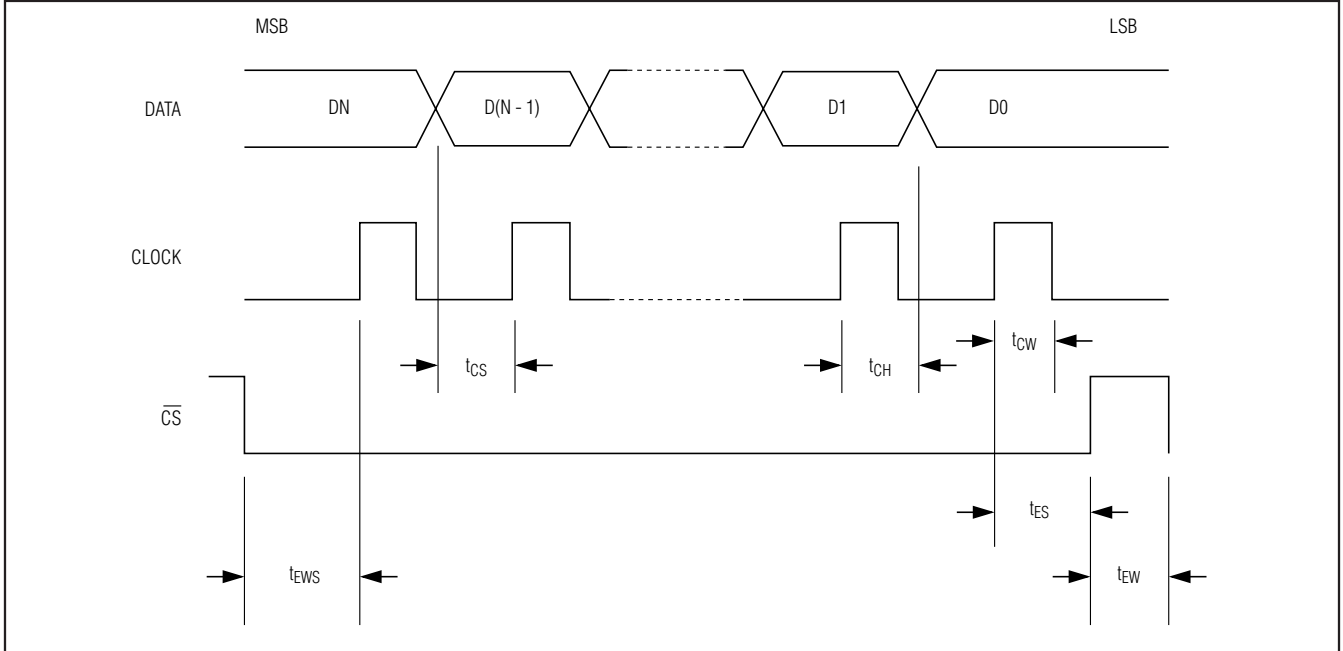

Figure 1. SPI Timing Diagram

Table 2. SPI Data Format

FUNCTION	BIT	DESCRIPTION
On-Chip DAC	D7	Bit 7 (MSB) of on-chip DAC used to program the analog attenuator
	D6	Bit 6 of DAC
	D5	Bit 5 of DAC
	D4	Bit 4 of DAC
	D3	Bit 3 of DAC
	D2	Bit 2 of DAC
	D1	Bit 1 of DAC
	D0 (LSB)	Bit 0 (LSB) of the on-chip DAC

# 50MHz to 1000MHz High-Linearity, Serial/Analog-Controlled VGA

## External Bias

Bias currents for the driver amplifier are set and optimized through external resistors. Resistors R1 and R1A connected to RSET (pin 18) set the bias current for the amplifier. The external biasing resistor values can be increased for reduced current operation at the expense of performance. See Tables 4 and 5 for details.

## Pin-Compatibility Considerations

The MAX2067 is a simplified version of the MAX2065 analog/digital VGA. The MAX2067 does not contain a digital attenuator and parallel inputs D0–D4. The associated input/output pins are internally connected to ground (Table 3). Ground the unused input/output pins to optimize isolation. (See the *Typical Application Circuit*.)

## +5V and +3.3V Supply Voltage

The MAX2067 features an optional +3.3V supply voltage operation with slightly reduced linearity performance.

## Layout Considerations

The pin configuration of the MAX2067 has been optimized to facilitate a very compact physical layout of the device and its associated discrete components.

The exposed paddle (EP) of the MAX2067's 40-pin thin QFN-EP package provides a low thermal-resistance path to the die. It is important that the PCB on which the MAX2067 is mounted be designed to conduct heat from the EP. In addition, provide the EP with a low-inductance path to electrical ground. The EP **must** be soldered to a ground plane on the PCB, either directly or through an array of plated via holes.

**Table 3. MAX2065/MAX2067 Pin Comparison**

PIN	MAX2065	MAX2067
8	SER/PAR	GND
9	STATE_A	GND
10	STATE_B	GND
11	D4	GND
12	D3	GND
13	D2	GND
14	D1	GND
15	D0	GND
23	ATTEN2_OUT	GND
29	ATTEN2_IN	GND

**Table 4. Typical Application Circuit Component Values (HC Mode)**

DESIGNATION	VALUE	SIZE	VENDOR	DESCRIPTION
C1, C2, C7, C12	10nF	0402	Murata Mfg. Co., Ltd.	X7R
C3, C4, C6, C8, C9	1000pF	0402	Murata Mfg. Co., Ltd.	C0G ceramic capacitors
C10, C11	150pF	0402	Murata Mfg. Co., Ltd.	C0G ceramic capacitors
L1	470nH	1008	Coilcraft, Inc.	1008CS-471XJLC
R1, R1A	10 $\Omega$	0402	Panasonic Corp.	1%
R2 (+3.3V applications only)	1k $\Omega$	0402	Panasonic Corp.	1%
R3 (+3.3V applications only)	2k $\Omega$	0402	Panasonic Corp.	1%
R4 (+5V applications and using internal DAC only)	47k $\Omega$	0402	Panasonic Corp.	1%
U1	—	40-pin thin QFN-EP (6mm x 6mm)	Maxim Integrated Products, Inc.	MAX2067ETL+

# 50MHz to 1000MHz High-Linearity, Serial/Analog-Controlled VGA

**MAX2067**

**Table 5. Typical Application Circuit Component Values (LC Mode)**

DESIGNATION	VALUE	SIZE	VENDOR	DESCRIPTION
C1, C2, C7, C12	10nF	0402	Murata Mfg. Co., Ltd.	X7R
C3, C4, C6, C8, C9	1000pF	0402	Murata Mfg. Co., Ltd.	COG ceramic capacitors
C10, C11	150pF	0402	Murata Mfg. Co., Ltd.	COG ceramic capacitors
L1	470nH	1008	Coilcraft, Inc.	1008CS-471XJLC
R1	24Ω	0402	Vishay	1%
R1A	10nF	0402	Murata Mfg. Co., Ltd.	X7R
R2 (+3.3V applications only)	1kΩ	0402	Panasonic Corp.	1%
R3 (+3.3V applications only)	2kΩ	0402	Panasonic Corp.	1%
R4 (+5V applications and using internal DAC only)	47kΩ	0402	Panasonic Corp.	1%
U1	—	40-pin thin QFN-EP (6mm x 6mm)	Maxim Integrated Products, Inc.	MAX2067ETL+

# 50MHz to 1000MHz High-Linearity, Serial/Analog-Controlled VGA

## Typical Application Circuit

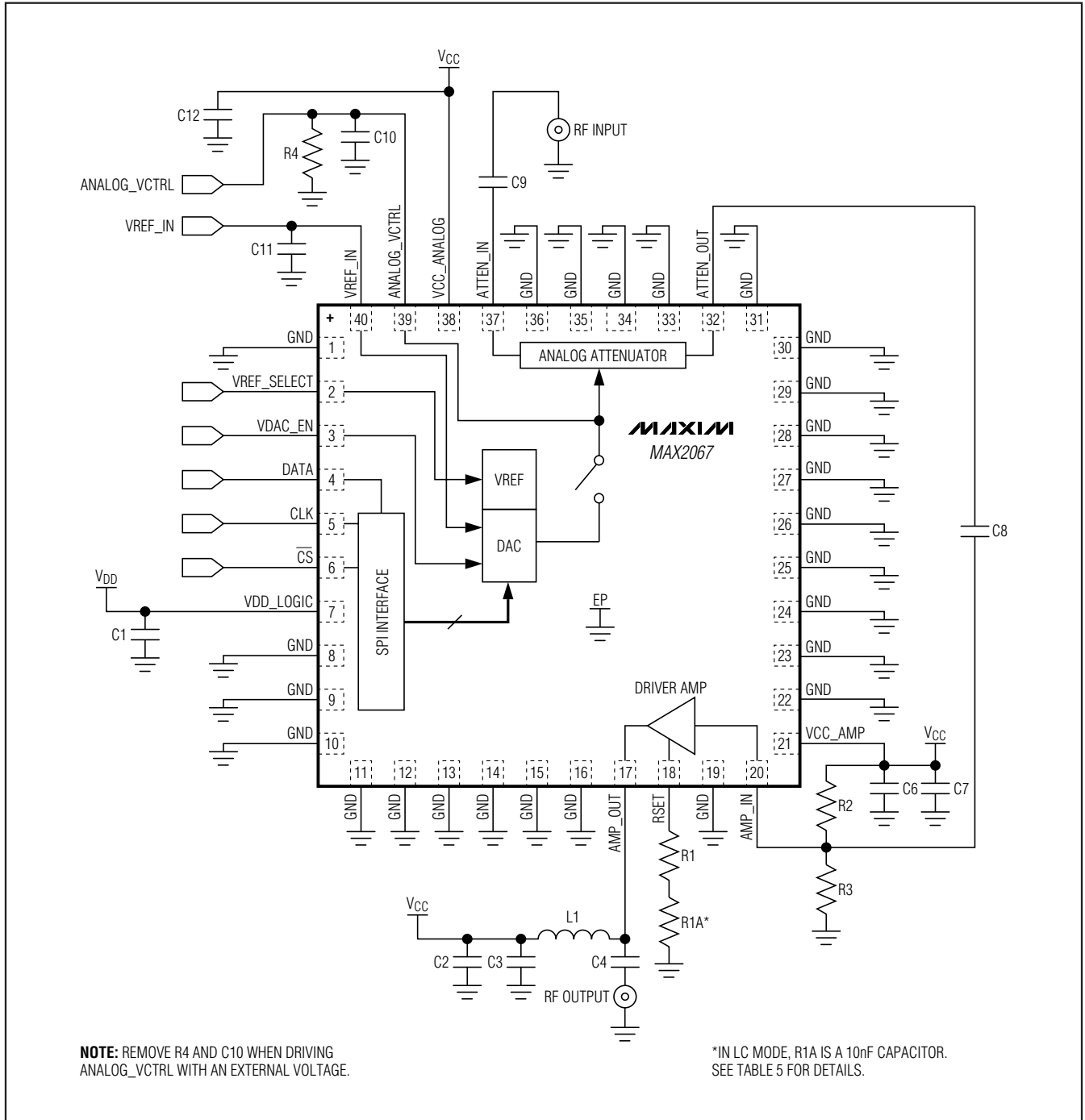

# 50MHz to 1000MHz High-Linearity, Serial/Analog-Controlled VGA

## Pin Configuration/Functional Block Diagram

**MAX2067**

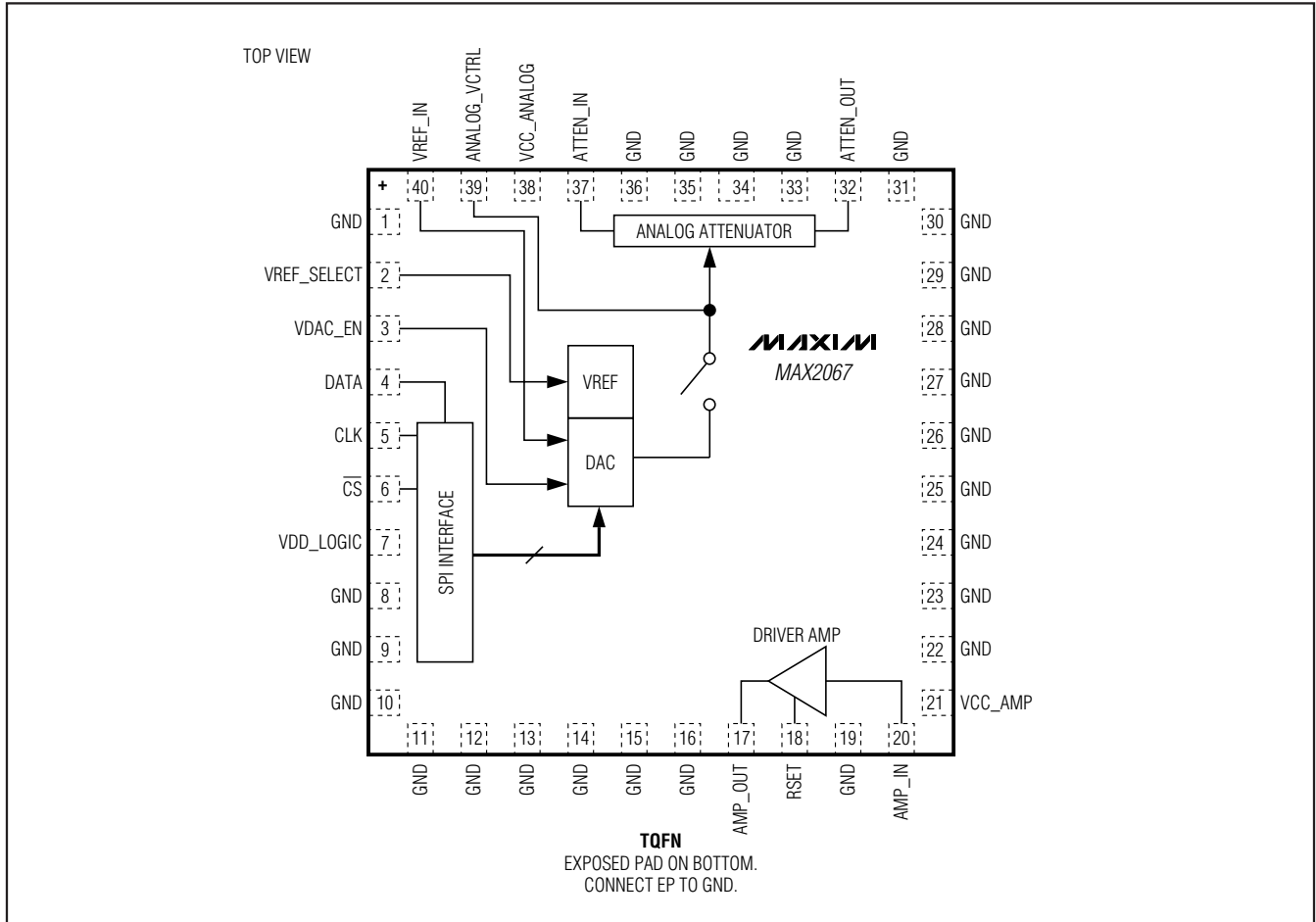

### Chip Information

PROCESS: SiGe BiCMOS

### Package Information

For the latest package outline information, go to [www.maxim-ic.com/packages](http://www.maxim-ic.com/packages).

PACKAGE TYPE	PACKAGE CODE	DOCUMENT NO.
40 Thin QFN-EP	T4066-3	<a href="#">21-0141</a>

Maxim cannot assume responsibility for use of any circuitry other than circuitry entirely embodied in a Maxim product. No circuit patent licenses are implied. Maxim reserves the right to change the circuitry and specifications without notice at any time.

Maxim Integrated Products, 120 San Gabriel Drive, Sunnyvale, CA 94086 408-737-7600 23